

# CATALOGO / CATALOGUE

## 2005

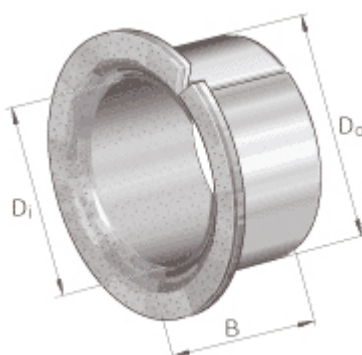

**FC** è un'azienda specializzata nella produzione e commercializzazione di boccole (acciaio, bronzo, ghisa, plastica) per macchine movimento terra e per il settore industriale. L'azienda dispone di uno stabilimento di circa 1000 mq coperti in cui concentra i propri macchinari e personale per la produzione di boccole che commercializza sia in Italia che all'estero.

I traguardi conseguiti in un settore in costante evoluzione e le risorse umane che permettono di consolidare il marchio FC Boccole spingono costantemente l'azienda al miglioramento delle fasi produttive, garantendo ai clienti prodotti di alta qualità sotto il profilo tecnico, durata e sicurezza.



**FC** is a manufacturer of steel, bronze, cast-iron, plastic bushes to satisfy industrial and agricultural requirements. At present the company comprises in area of 1000 square meters covered.

The goal achieved in a sector in constant development and human resources allow FC Boccole to consolidate its trademark all over the world, driving the company to improve the various production phases, always increasingly ensuring its customers top quality products under a technical, service-life, and safety profile.

**FC BOCCOLE – ITALY**





**effeci**  
boccole



# CATALOGO BOCCOLE CATALOGUE – STEEL BUSHES

I nostri prodotti sono utilizzati come ricambi per il settore agricolo (macchine movimento terra) e quello industriale. Le misure di seguito riportate sono indicative. Possono essere personalizzate secondo i disegni forniti dal cliente.

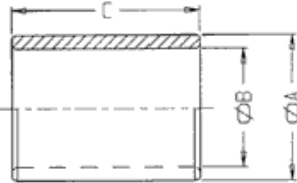
The target of our products is agricultural and industrial area. The products can be realized with reference to standard shape or engineering design.

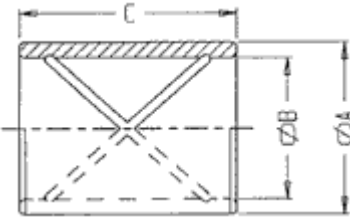
	<b>TIPO / TYPE</b>	<b>Diametro esterno External Diameter (mm)</b>	<b>Diametro Interno Internal Diameter (mm)</b>	<b>Lunghezza Lenght (mm)</b>
	<b>Cilindrica liscia Cylindrical smooth COD. FC-LS</b> 	30 38 45 55 65 75 85 95 105 115 125 135 145 155	20 30 35 45 55 65 75 85 95 105 115 125 135 145	20-70 30-85 30-100 30-100 35-100 35-100 35-100 40-120 50-120 60-130 70-130 80-150 80-150 80-170
	<b>Cilindrica con ragnatura Cylindrical with groove COD. FC-RA</b> 	30 38 45 55 65 75 85 95 105 115 125 135 145 155	20 30 35 45 55 65 75 85 95 105 115 125 135 145	20-70 30-85 30-100 30-100 35-100 35-100 35-100 40-120 50-120 60-130 70-130 80-150 80-150 80-170





**effeci**  
boccole



# CATALOGO BOCCOLE CATALOGUE – STEEL BUSHES

I nostri prodotti sono utilizzati come ricambi per il settore agricolo (macchine movimento terra) e quello industriale. Le misure di seguito riportate sono indicative. Le misure e le forme possono essere personalizzate secondo i disegni forniti dal cliente.

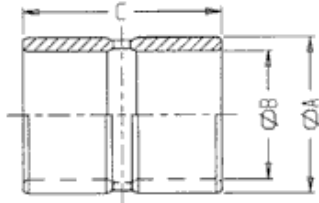
The target of our products is agricultural and industrial area. The products can be realized with reference to standard shape or engineering design.

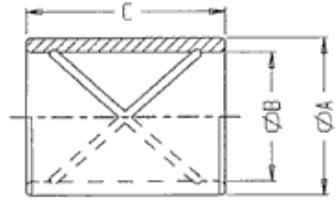
	TIPO	Diametro esterno <i>External Diameter</i> (mm)	Diametro Interno <i>Internal Diameter</i> (mm)	Lunghezza <i>Length</i> (mm)
	<b>Cilindrica con foro</b> <i>Cylindrical with hole</i>  <b>COD. FC-FO</b>  	30 38 45 55 65 75 85 95 105 115 125 135 145 155	20 30 35 45 55 65 75 85 95 105 115 125 135 145	20-70 30-85 30-100 30-100 35-100 35-100 35-100 40-120 50-120 60-130 70-130 80-150 80-150 80-170
	<b>Cilindrica con foro o senza e ragnatura</b> <i>Cylindrical with hole and groove</i>  <b>COD. FC-FR</b>  	30 38 45 55 65 75 85 95 105 115 125 135 145 155	20 30 35 45 55 65 75 85 95 105 115 125 135 145	20-70 30-85 30-100 30-100 35-100 35-100 35-100 40-120 50-120 60-130 70-130 80-150 80-150 80-170



**effeci**  
boccole



# CATALOGO BOCCOLE CATALOGUE – STEEL BUSHES

MODULO RICHIESTA PREVENTIVO / HOW TO SUBMIT AN ESTIMATE

## FAX

---

TO	FC di Fracarolli Stefano	From
ATT	Responsabile Commerciale	(Ditta/Company)
C/C		Direct tel
Fax N.	+ 39 0522 756160	Fax
		E-mail
		Ref
		Date

---

:

### DATI / DETAILS

<b>CODICE / CODE</b>	<b>Diametro esterno External Diameter (mm)</b>	<b>Diametro Interno Internal Diameter (mm)</b>	<b>Lunghezza Lenght (mm)</b>	<b>Numero pezzi Total parts</b>

### NOTE

---